

Love of life begins with "Rcom"

For Education

mini

REV. 3.2

DIGITAL EGG INCUBATOR
USER'S MANUAL
PRO MINI

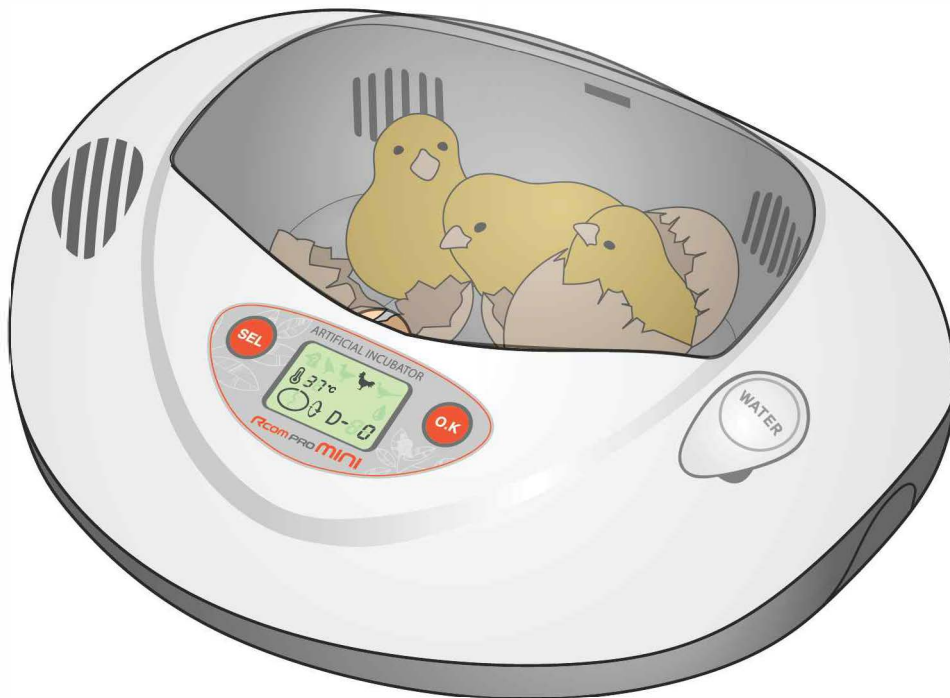

Rcom



How to Use Rcom PRO MINI

1. Basic Component Parts	3
2. Description of function of each part	4
3. Cautions	5
4. How to use the incubator	6
(1) How to set incubation	6
(2) How to set the incubator for other species of birds	8
(3) How to turn off the incubator	9
5. Pre- and post-management of incubation	10
6. Maintenance and storage after using the incubator	11
7. How to clean the incubator	12
Appendix 1. How to change the manual temperature setting	21
Appendix 2. Accessories	23

Raising of chicks



1. Date of hatching / Date of stop turning eggs by species	13
2. What is a fertilized or unfertilized egg?	13
3. Examination of an egg (EZ Scope manual)	14
4. Making a nest for chicks	16
5. Feeding the chicks	17
6. Self Diagnosis and Troubleshooting	17
7. Incubation diary	18
8. Process of chick incubation	19

Explanation of marks in the text



Caution: Caution mark against a fault that can cause damage, trouble, or failure of incubation



Tip: References or useful suggestions in using RCOM



Warning of actions which may be dangerous or cause damage to the incubator.

1. Basic Component Parts

Adaptor

A device to supply 12V power to the main body

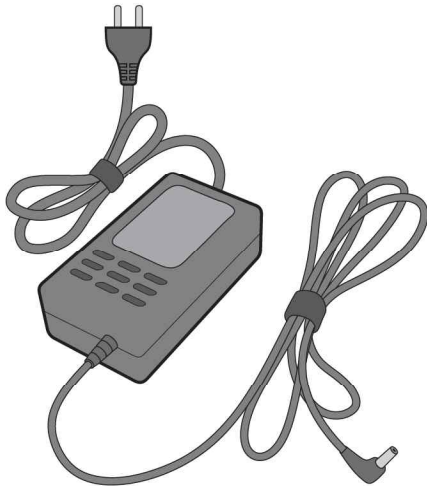

window

For a clear view of the incubation process.
Be careful to prevent it from being scratched or broken.

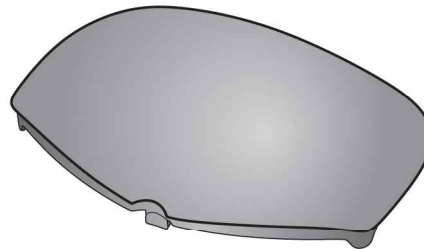

Hatching pad

Insert this tray under the eggs to keep the incubator clean when the eggs start hatching.

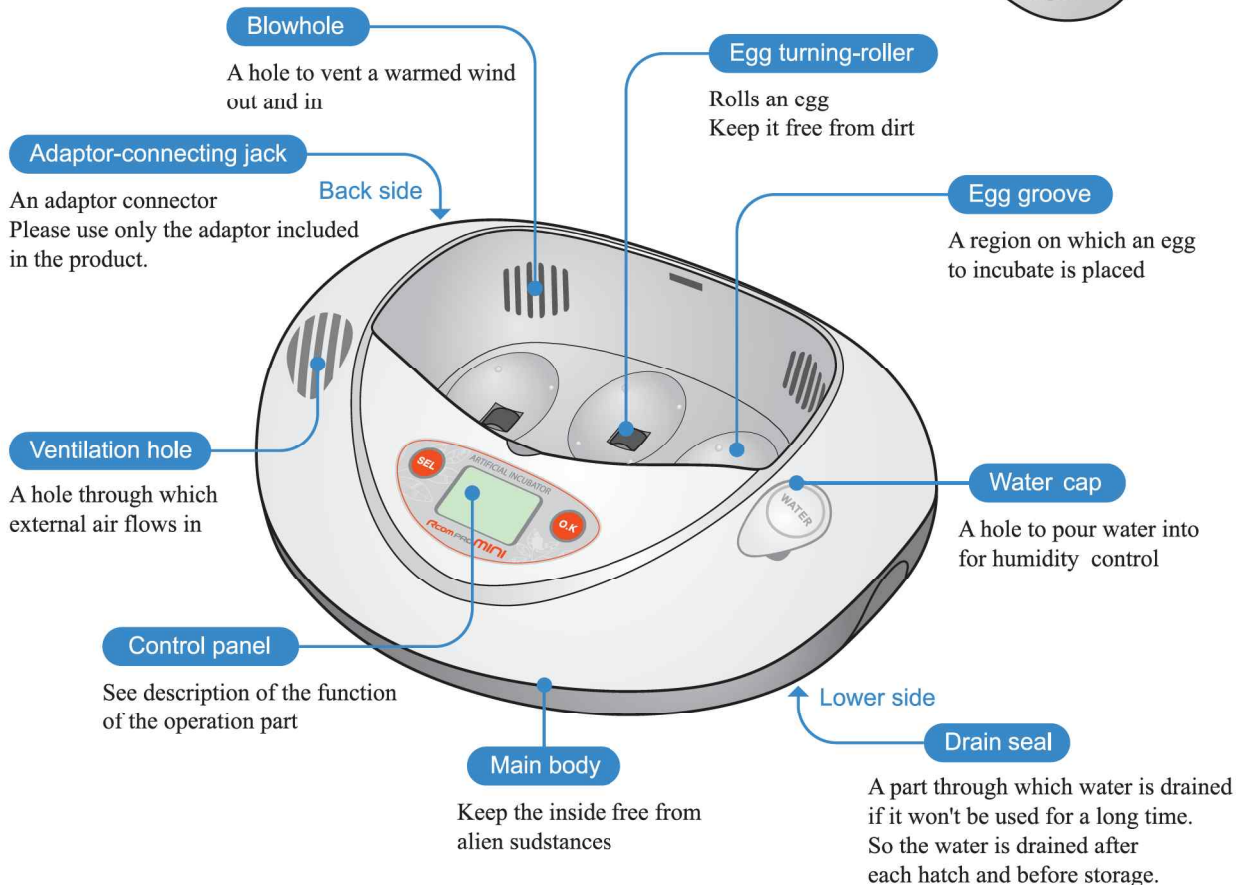
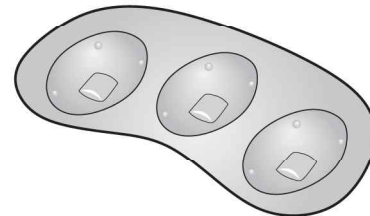

2. Description of the Function of the Control Panel

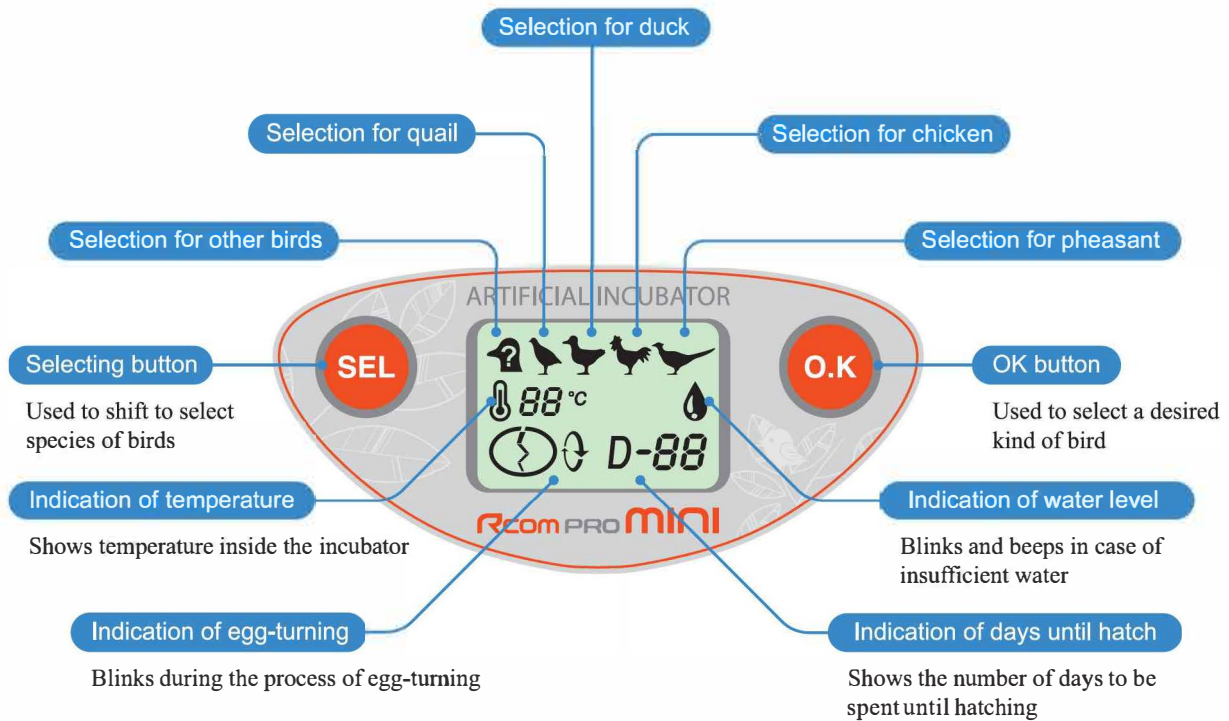

General Cautions

CAUTION Watch out these items below when you use.



Don't drop it or jar me.

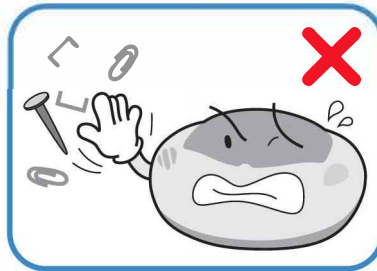

Don't put metals like nails and clips inside me.

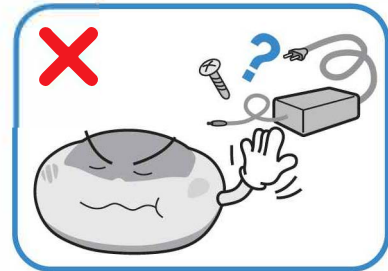

Don't use other parts with me.

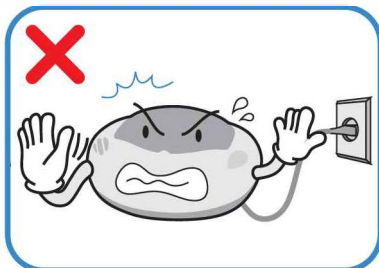

Never pull my plug out of the socket during the course of incubation.



Don't turn me over, or water can spill from the main body.

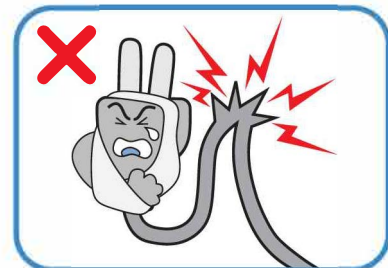

Don't apply excessive pressure to my power plug.

CAUTION Please keep your wet hands away from the adaptor and do not put in quilts.

Cautions during Installment

CAUTION Avoid the following situations when you install me.

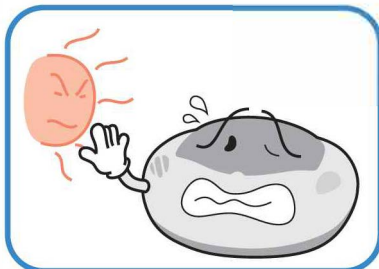

The direct rays of the sun

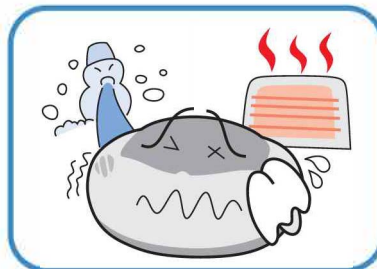

Excessively cold or hot weather



Too much water or moisture

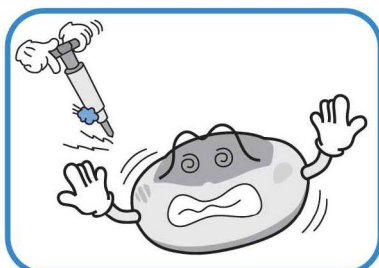

Severe shock or instability



Too much dust or dirt



Other people touching me

4. How to Use the Incubator

mini

(1) How to Set Incubation

The Incubation Room is a confined space for setting and operating an incubator. Because the incubation room environment has a considerable effect on hatch rate, it's recommended to control the environment for setting up an incubator; there should be little noise and vibration around and temperature ranging 28°C (82.4°F) with small variation in temperature.

Especially, if there are frequent occasions when the temperature drops suddenly at night, compared with daytime, be sure to check from time to time and pay attention so that the incubator is not directly exposed to sunlight during daytime.

1

Insert the adaptor in the connecting jack at the bottom of the main body and put the plug in a socket. The LCD display will come on and show temperature.

Tip There can be some smell the first time you use the incubator, that is normal.

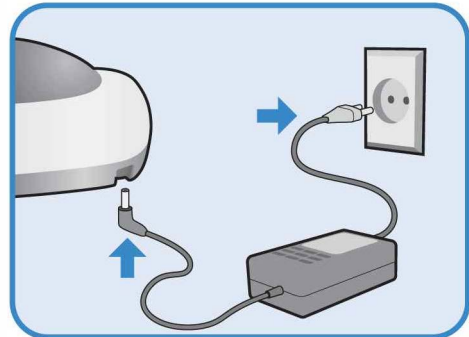

2

Lift the lid at the right side of the main body and carefully pour water into the hole. As it fills with water, a Styrofoam ball rises; if the ball blocks the hole, it means it is full. The light indicating low water will come on about every five days during incubation. You should add tepid water to refill.

Tip The light for filling up of water can remain for a while after you filled up.

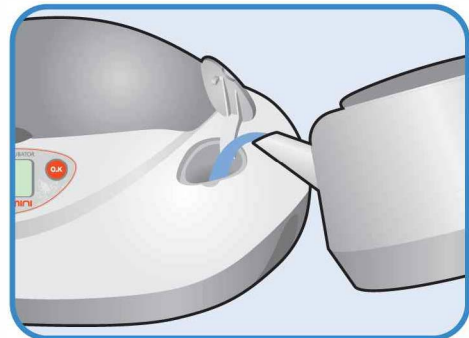

! After filling up the water, never shake or turn over the main body of the incubator. This would cause water to spill inside the incubator and could cause a breakdown.

3

Open the view window and take out the hatching pad. After that, put a fertilized egg to incubate in the egg groove and then close the view window.

! Do not throw away the hatching pad because it is needed when the eggs hatch.

! Be careful to close the view window completely; if not, the temperature will fail to go up.

Tip The egg to incubate must be a fertilized egg. See 'What Is a Fertilized or Unfertilized Egg?' on page 13 for description of a fertilized egg.

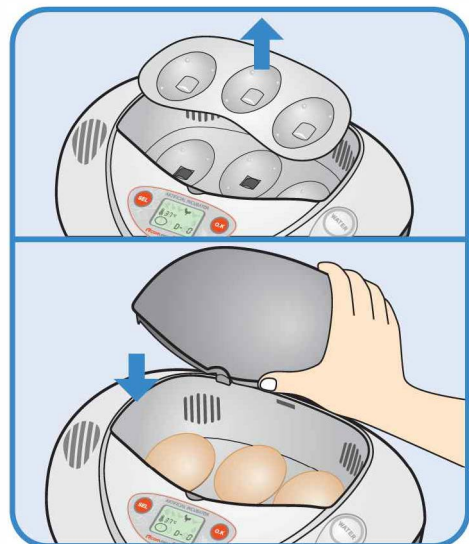

4

Press the selecting button **SEL** on the control panel and the species icon on the LCD display blinks; Each time the button is pressed, a different species icon will blink. Select the species you want to incubate.

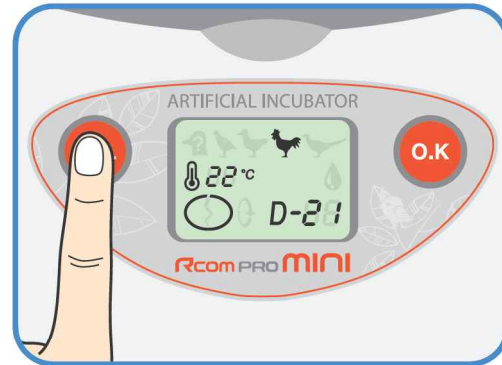
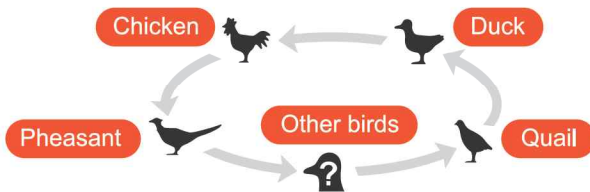

5

Select the kind of birds to incubate and press the OK button **O.K** for about two seconds. The icon will blink, the light will turn on inside the incubator, and the beeper will sound and the incubation will commence.

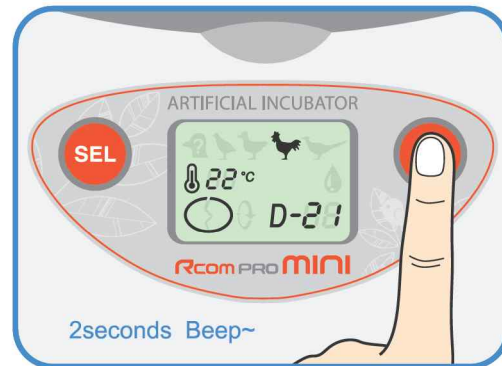

6

Now Mycom will automatically optimize the condition of all functions.

It will keep temperature and humidity proper and let the egg turned every an hour. In addition, there will be the alert sound in case of insufficient water, or abnormal temperature.

Pre-notice alarm sounds 10 seconds before eggs are turned.



Tip What is egg-turning?

It is literally to turn an egg and is also called egg exercise. Egg-turning serves to have a healthy chick and helps good egg incubation.

It is necessary until three days before a chick hatches.

4. How to Use the Incubator

mini

(2) How to Set the Incubator for Other Species of Birds

It is to incubate any other birds than quail, duck, chicken and pheasant.

1

Press the selecting button **SEL** on the operation part to select any other birds. 

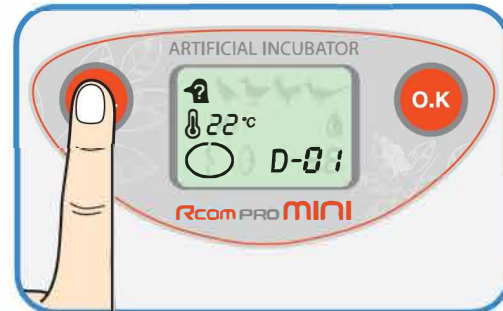

2

Press the OK button **O.K** for a short time of less than one second.
And hatching time display **D-01** blinks.

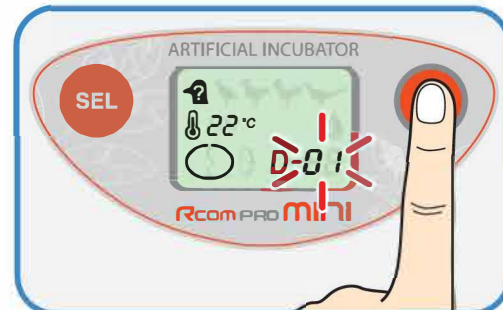

3

Press the selecting button **SEL** to change the number of days of incubation.
According to the kind of birds, set up the number of days of incubation by pressing the button several times.
(e.g. Golden or silver pheasant = 23 days)
The number of days of incubation can be set in the range of one to forty days.

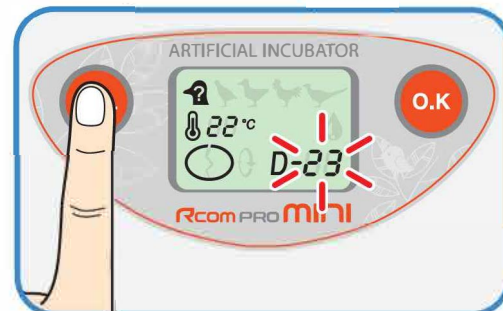

4

Make sure that the desired number blinks, then keep the OK button **O.K** pressed for about two seconds until a beeper is heard to complete setting.

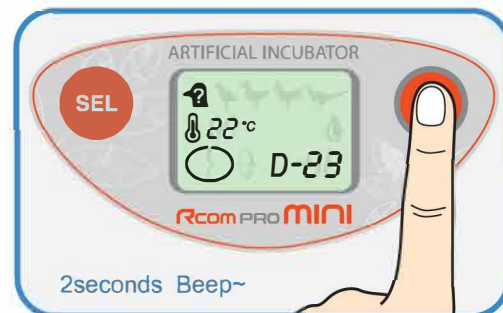

TIP In case that incubation has interrupted due to an operating error during normal incubation, incubation can be resumed by using the above function to input the number of remaining days until the hatching day.

For example, in the case of an egg of which the incubation term is 21 days, if incubation interrupted on the 15th day, all you have to do is input 6 days because 6 days remains until the incubation day (21 - 15 = 6) to resume incubation.

(3) How to Stop Operating the Incubator

! The following operation is prohibited exclusive of special cases.
If normal operation is interrupted by this operation, it can kill an egg.

Tip Stop incubation only when

The eggs have died and you need to restart the whole incubation process.
The eggs may have died because of a long time power failure, or faulty eggs.
The incubator may need to be reset if the original setting was for an incorrect number of incubation days.

! Short term power failure may or may not kill an egg if the room is at a mild temperature.
In case of short power failure, continue incubation until the fixed date

Tip Although power is off and on due to power failure or carelessness, the incubator may maintain the previous setting, if the interruption was short.

How to Stop Operation

Keep two buttons on the operation part pressed at the same time over three seconds, and incubation will stop with a beeper. Here, the light will be turned off inside the incubator.

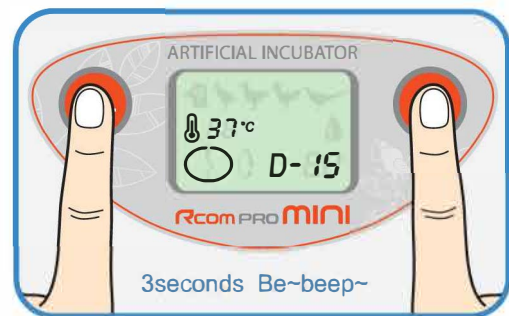

5. Pre- and Post-Incubation Management



When egg-turning is over 18 days later (in case of chicks), open the view window and pick out the eggs carefully and put the hatching pad inside of incubator. After that, put the eggs on the pad and close the view window. This is to prevent alien substances that came out of the egg during hatching from entering the roller or sticking to the main body.

TIP The incubator turns off the egg-turning indication  on the LCD display when the time of egg-turning is over. This is the time to place the hatching tray in position for hatching.

When the egg begins to hatch, it is desirable not to open the view window frequently. On opening the view window, moisture and warm air may leak out. Low humidity can cause dried-up feathers of the chick to stick to the shell, which prevents the chick from getting out of the egg.

TIP It takes about 12 hours for chicks to get out of the egg completely after eggs have pipped. Don't open the view window even if the chicks seem to have difficulty getting out of eggs.

After chicks hatched, leave them in the main body for about a day. They may dry their feathers and take a rest for the period of time. Here, don't feed them. A chick is born with nutriments so that they need not to be fed for about one to two days.

TIP The hatching can be delayed about 2~3days according to the conditions of egg. When the date of hatching is over, the over date is indicated in LCD displayer.

A day after their hatching, get them out of the incubator to move into a nest. The packing box of the product can be used as a nest.

 Be sure to remove hatching tray and make the incubator clean.

TIP See 'How to Make a Chick a Nest' on page 16.

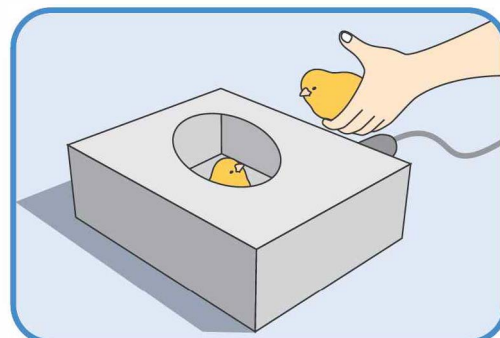
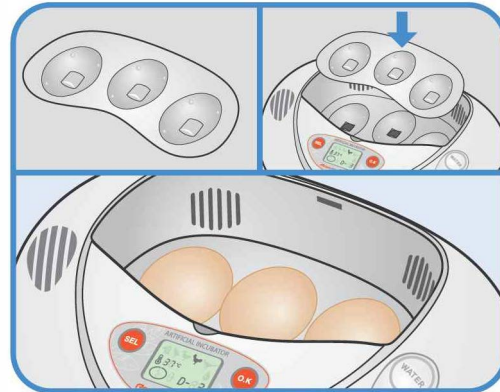

1

Pull the plug out of the socket and detach the adaptor from the main body.

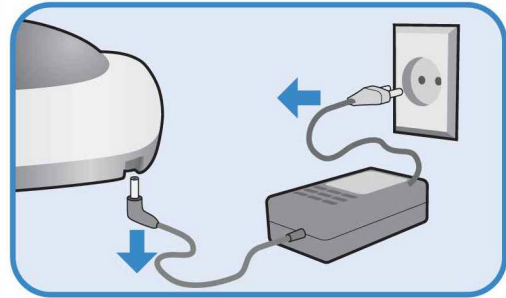

2

Place the main body on a table, pull the right side of the main body out about a third as seen in the figure, pull out the water cap at the bottom of the main body, and water runs out. Here, tilt the main body from side to side to drain water from the main body completely.

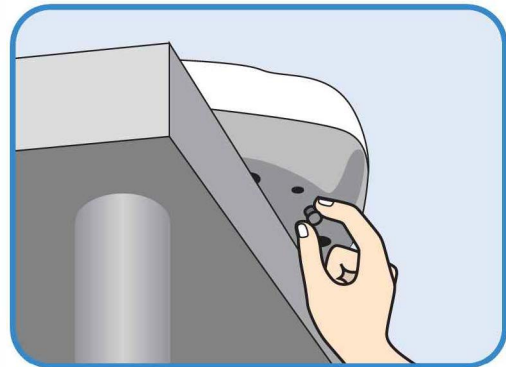

Be careful not to lose the drain seal.

Place a basin under the table to catch water.

3

Clean the product with moist cloth and dry it in an airy place before storing it.

Don't clean the product with such organic solvents as benzene and paint thinner.



7. How to Clean the Product

mini

As dried feathers of chicks can form dust to enter the main body during several courses of incubation, it is desirable to clean the product after each course of incubation.

1 2 The same to 1 and 2 in 'Maintenance and Storage After Using the Product' on the previous page.

3
Detach the floor head from the suction pipe of the vacuum cleaner.

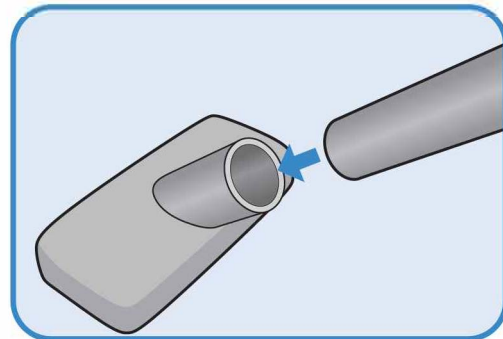

4
Open the view window of the incubator and place the suction pipe of the vacuum cleaner over air circulation hole at the fore part of the main body and start the cleaner to remove dust from the main body effectively. If there is alien substance near the egg roller, the machine can fail to work, so, vacuum cleans the roller, too. Then wipe over with a damp cloth, and make sure the incubator is dry before storage.



1. Date of Hatching / Date for Stopping Rolling an Egg by Kinds of Birds

Kinds of birds	Quail	Rooster	Duck	Pheasant	Turkey
Number of days to be spent until incubation	17	21	28	23	28
Date when stopping rolling eggs	14th day	18th day	25th day	20th day	25th day

Kinds of birds	Pigeon	Golden pheasant	Silver pheasant	Society finch	Parakeet
Number of days to be spent until incubation	17	23	23	14	19
Date when stopping rolling eggs	14th day	20th day	20th day	11th day	16th day

Common sense in incubation

A chick uses an 'eggshell-breaking tip' at the end of the upper bill to hatch an egg. It puts the pointed eggshell-breaking tip on the shell inside the egg and throws its head back to hatch the egg with ease. Egg tooth is detached from the bill by itself after hatching.

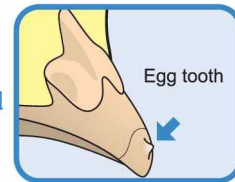

2. What Is a Fertilized or Unfertilized Egg?

Fertilized Egg

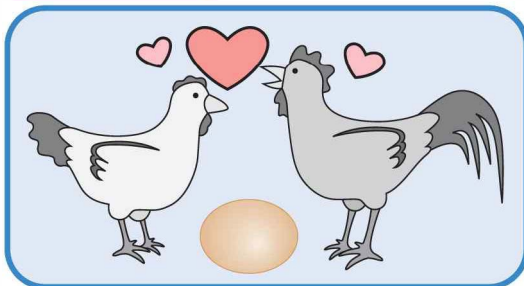

Fertilized egg is simply speaking, it means an egg laid by mating a hen and a cock. So it can become a chicken.

Unfertilized Egg

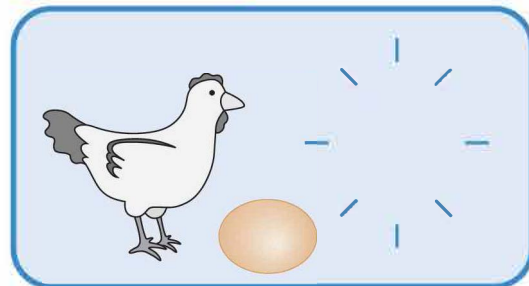

It is an egg we generally eat. As an unfertilized egg is laid by a hen alone, it cannot become a chicken.

Purchase of Fertilized Eggs

It is important to purchase fresh fertilized eggs in order to increase success rate of incubation.

You can purchase them from breeders.

It is desirable to see the date they were laid in order to select eggs that were laid within a week; the older an egg is, the harder it is to hatch.

It is also desirable to purchase eggs laid by a hen that is raised along with a cock in the country.

3. Examination of an Egg

mini

An egg is examined about three times during the course of incubation at a general hatchery.

First Examination

6th day after incubation starts

Blood vessels look spidery and an embryo's movement can be identified on examining carefully.



An unfertilized egg or a fertilized egg before incubation starts

Second Examination

12th day after incubation starts

Blood vessels become thicker and an embryo becomes bigger with brisker movements.

If blood vessels fail to be vivid or there is no movement, it can be an egg that stopped developing (dead).



6th day

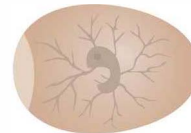

12th day

⚠️ If no blood vessel or embryo is observed, it is an unfertilized egg, which should be pulled out of the incubator.

Third Examination

18th day after incubation starts

As an embryo becomes bigger, all but an air chamber looks black. From this moment, stop rolling an egg.

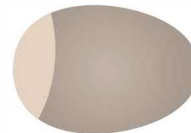

18th day

⚠️ During the examination, the ambient temperature is lower than that in the incubator. For this reason, it is desirable to conduct this examination in a warm room in less than 10 minutes. Be careful not to give a shock to the egg. Even an excessive shake can cause the egg to die of stress.

⚠️ If a shell is thick or has a rich color, it can be difficult to observe an egg.

Tip You can examine an egg every day since you aim at having observational learning; however, the more frequently you examine an egg, the higher the probability of failure in incubation.

How to Examine an Egg

At a Dark Place

Place an egg horizontally on smooth cloth or towel, and turn on a candle and place gently to the large end of the egg, and you can observe blood vessels or an embryo's movement.

Tip Observe it with the light switched off, for example, in a dark room by day.

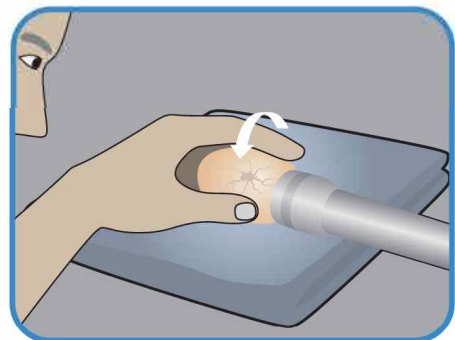



3. Examination of an Egg
(EZ Scope manual)

In the Light

* Option: EZ scope

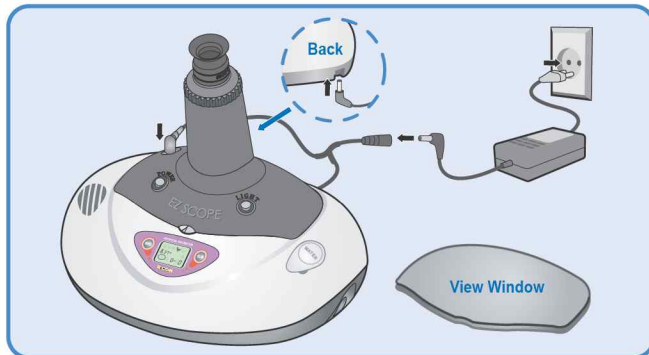
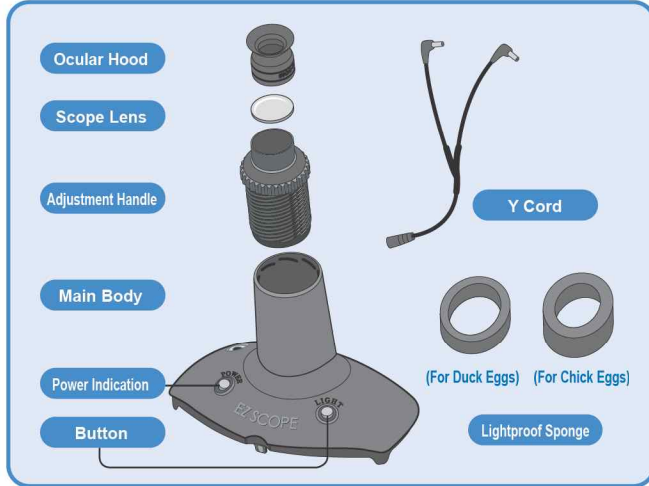

You can inspect the egg by assembling Rcom incubator with EZ Scope. After assemble, press the LIGHT button. You can control the focal point by turning the Adjustment Handle according to your sight.

! Be sure to replace EZ Scope with Rcom view window after egg inspection.

Tip The brighter the egg shell, the easier to inspect the inside. (Ex: Duck egg)



The notebook computer and webcam are not included in the product.

Tip EZ Scope helps you to monitor the incubation progress with your computer by using Webcam.

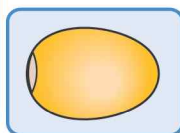

(An fertilized egg)

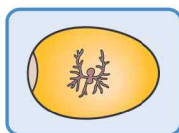

(5~8th day)

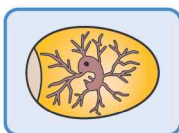

(9~10th day)

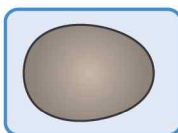

(15th day)

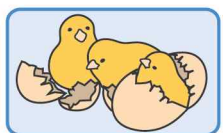

(Hatching)

1

Assemble the Scope as the picture on the right side.



2

Before use, replace proper lightproof sponge to your egg size.



! It is important to select proper lightproof sponge according to your egg size.

3

Open the view window of RCOM incubator.



4

Cover the EZ scope on the Rcom main body exactly.

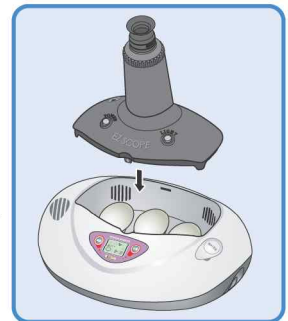

4. Making of a Nest for a Chick

mini

Since new-born chicks are excessively sensitive to cold, it is necessary to keep them warm. The temperature of inside nest must be 35~37°C (95~98.6°F) So a nest is indispensable to raise young chicks. Use the packing box of the product purchased to make a nest for chicks.

1

A low and heavy dish is good.
(To prevent water from spilling even if the chicks step on it.)
A bulb, a socket, and a cord can be purchased at hardware store.

⚠ Be sure to use a three-wavelength 20W bulb.
If you use a bulb over 20W, temperature goes up, possibly killing the chick or causing a fire.

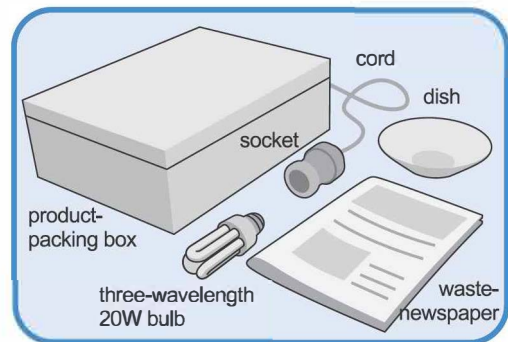

2

Make 30mm of diameter holes on the back side of box 100mm from the bottom

TIP Refer when making a hole.

Very cold place: Make a hole only at No. 1

Cold place: No. 1, 2

Warm place: No. 1, 2, 3

Very warm place: No. 1, 2, 3, 5

⚠ Be careful not to injure hands or other body parts with scissors

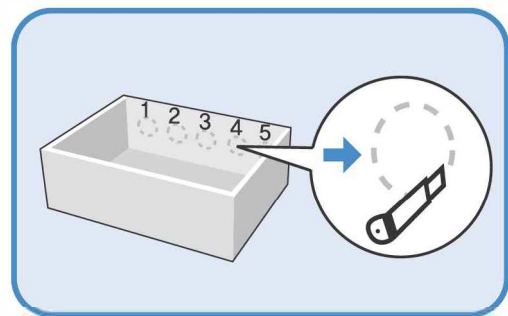

3

Insert the screw of the bulb in the hole inside the box, and then put the socket outside the box and fasten it.

⚠ Be sure to install the bulb without putting a plug in a socket.
Or you can get a shock.

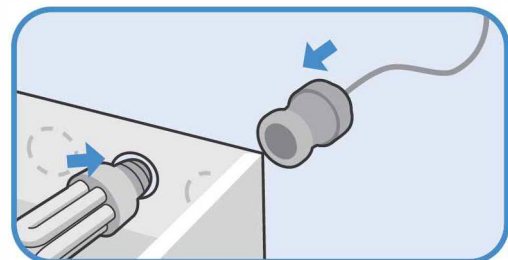

4

Cover the bottom with newspaper, tape crosswise top of dish for chicks not falling into dish put the dish at the corner, and pour a little water into it.

⚠ If there is too much water and a chick falls into water,
its feathers will get wet and it can die of loss of body heat.
Here, dry feathers with a hair dryer, etc.

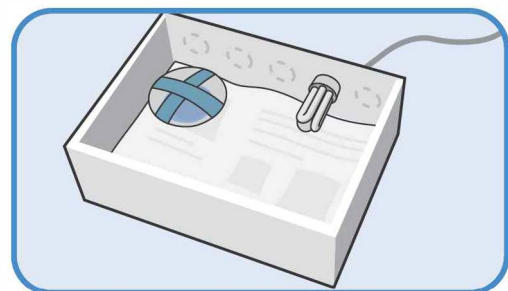

4. Making of a Nest for a Chick

5

About a day after chicks hatched, put them in the box and put the cover on. Put the plug in the socket and turn the light on.

TIP About two weeks after chicks hatched, they have well-grown feathers and becomes resistant to the circumstance. After that, you don't have to turn on the light.

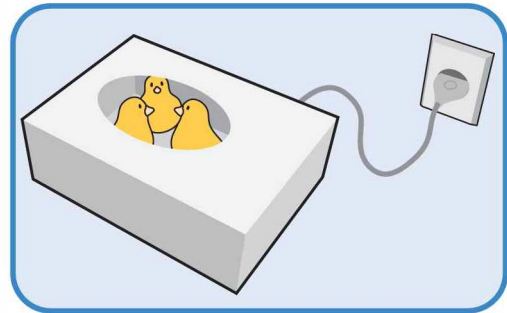

5. Feeding of a Chick

A day after a chick hatched, it has soft feathers and is so cute!

Around this time, it can be fed first. Feed it on the chopped-up yolk of a boiled egg along with water in a dish. Don't feed it too much however cute it is. Because it doesn't eat so much.

It is desirable to mix it with a little soil or sand. A bird has a gizzard and sand will promote the digestion.

A chick likes to eat chopped-up lettuce or cabbage.

Feed a chick on the yolk of an egg for about two days, then on a mix of the yolk and feed for chicks or hulled millet soaked in water, and on appropriate feed or moistened grains of cooked rice about a week later.

! If a chick peep-peeps loud, it needs a help.

It falls into water and gets its feathers wet, feels cold, gets hungry or thirsty, feels lonely, or gets frightened. Only when you take good care of it, it never peep-peeps loud.



6. Self Diagnosis and Troubleshooting

If you need detail information, please click "Self Diagnosis" on our website.

CIRCUMSTANCE	ITMES TO BE CONFIRMED	SOLUTIONS
When temperature is too low	<ol style="list-style-type: none"> 1. Check the incubator is operated. 2. Check the pad with overflowed water 3. Check the air circulation FAN is working. 	<ol style="list-style-type: none"> 1.Refer to No.5 on the page 7 2. Drain water in side of incubator, dry it under well ventilation. 3. Clean the FAN (There could be foreign substance, such as egg shell)
When eggs do not turn.	<ol style="list-style-type: none"> 1. Put small object on the egg, wait for 1 hour and then small object is still on the egg 2. Using small egg tray 	<ol style="list-style-type: none"> 1. Initialize incubator(Refer to the page 9) and then restart incubator (Refer to the page 7) 2. Wrap the roller with paper tape.
Water leaking (see the water drop in the Display)	<ol style="list-style-type: none"> 1. Check the drain seal (Blue). 2. Check the incubator is filled with too much water. 3. Check whether the incubator is moved or leaned side without draining water. 	<ol style="list-style-type: none"> 1. If you don't have the drain seal, replace with eraser or rubber and tape it. 2. When Styrofoam ball is rise, stop pouring water. 3. Drain water completely inside of incubator and dry it under ventilati on for one day.

7. Incubation Diary

mini

Incubation Diary

Incubation starts Date: Y M D Where the egg was purchased: Name of the farm producing the egg: Date that the egg was laid: Y M D	First examination Date: Y M D What has been observed:
Second examination Date: Y M D What has been observed:	Third examination Date: Y M D What has been observed:

Record of the Hatching Process

(1) Name of chick:	Features (color, appearance, habits, etc.):
Time the egg began to hatch : Y M D Minute Time it got out of the egg : Y M D Minute Time the egg-tooth fell off : Y M D	
(2) Name of chick:	Features (color, appearance, habits, etc.):
Time the egg began to hatch : Y M D Minute Time it got out of the egg : Y M D Minute Time the egg-tooth fell off : Y M D	
(3) Name of chick:	Features (color, appearance, habits, etc.):
Time the egg began to hatch : Y M D Minute Time it got out of the egg : Y M D Minute Time the egg-tooth fell off : Y M D	

- On the 2nd day after incubation starts** The head begins to occur along with eyes and the heart and blood vessels start to grow.
- 4th day** Brains are divided into the forebrain, the midbrain, and the hindbrain. The heart grows much bigger and blood vessels spread wide on the film of the yolk.
- 6th day** Wings and limbs begin to appear and brains and eyes become clear. The embryo begins to move by itself.
- 8th day** Brains are settled in the head completely. The neck becomes longer; the bill develops remarkably; and wings and limbs are separated.
- 10th day** Wings and limbs are separated completely and toes form. Egg tooth begins to occur and feathers start to grow.
- 12th day** It becomes much bigger and begins to hear for the first time. Feathers grow so that you can see them and the framework becomes solid.
- 14th day** With the head lowered toward the trunk, the back is bent to the left. Feathers cover the entire body with the head toward the air chamber.
- 16th day** As the head moves to under the right wing, it settles down at a position good for hatching.
- 18th day** The amount of amniotic fluid decreases and the chick prepares for hatching. It is time to stop rolling an egg.
- 19th day** The air chamber becomes much bigger and the yolk is settled in the body. The bill is held out toward the air chamber and lung-breathing starts.
- 20th day** The yolk is settled completely in the body and the navel hasn't closed yet. The yolk that entered in the body becomes a nutriment for two to three days after incubation.
- 21th day** The chick begins to use Egg tooth to break the shell. Over time, it uses limbs to push the shell and turns round to break it round. Low humidity can cause dried-up feathers to stick to the shell, preventing the chick from turning round and thus from hatching. It takes about 12 hours to break the shell completely and get out of the egg.

Visit the website to get details on the incubation process through photos and moving pictures.

Accessories

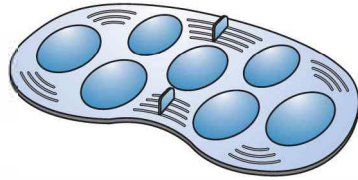

Quail egg tray (Model No. : SR-A07)



Goose egg tray (Model No. : SR-A01)

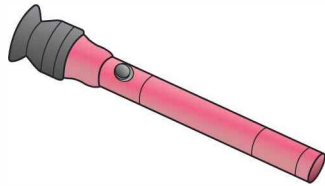

Rcom candler (Model No. : RC-100)

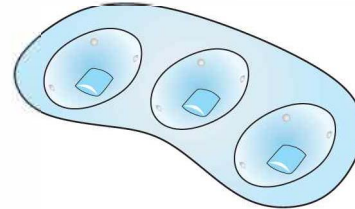

Clear hatching pad (Model No. :RT-300)

Specifications

1-1 : NAME : Rcom PRO MINI
1-2 : MODEL NO. : PX-03

Power (Adaptor out-put)	DC12[V] 1.2[A] ADAPTOR
Power Consumption	Approx. 10[W] MAX.
Working Temperature	15 ~ 38[°C]
Measurement	W :260 L :200 H :110 [MM]
Weight	Net weighth: 700[g] Gross weighth: 1,770[g]

⚠ Hatching result can be changed by a large number of factors. Autoalex Co.,Ltd. will not take a responsibility for loss of eggs or chicks under any circumstances such as hatching failure, user's carelessness, power failure, or malfunction.

⚠ Be sure that the incubator works without any problem before placing eggs in the incubator.

Rcom Incubator Series

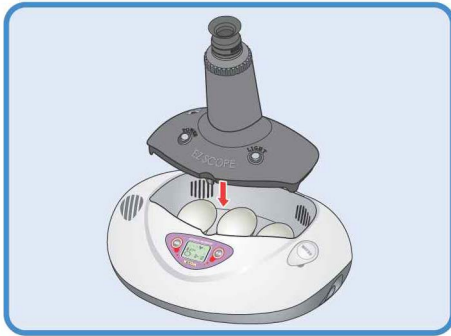

Rcom PRO MINI (PX-03)



Rcom KINGSURO MAX 20 (MX-SURO)



Rcom MAX 20 (MX-20)



Rcom PRO 20 (PX-20)



Rcom reptiles PRO 90 (PX-R90)



Rcom reptiles MAX 60 (MX-R60)

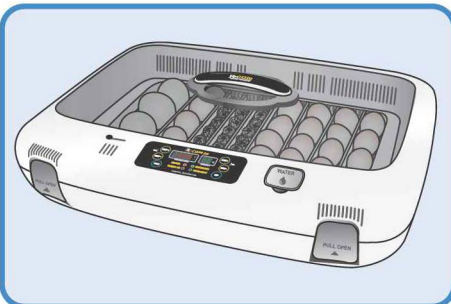

Rcom MAX 50 (MX-50)

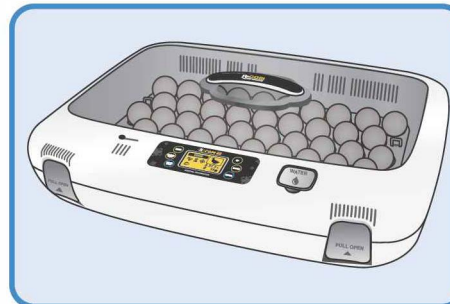

Rcom PRO 50 (PX-50)



Rcom BROODER&ICU (MX-BS500(N))



Rcom MARU MAX 500 (MX-500S)

Rcom MINI PART LIST

Image	Part No	Names of goods
	H03-E101-10	H03 Body
	H03-E102-10	H03 Bottm
	H03-E100-10	H03 Window
	H03-E103-10	H03 Water Cap
	H03-109-10	H03 Final Gear
	H03-117-10	H03 Idle Gear
	H03-E114-10	H03 Counter Gear-A
	H03-E115-10	H03 Counter Gear-B
	H03-A119-10	H03 Shaft-A ASM
	H03-A120-10	H03 Shaft-B ASM
	H03-E121-10	H03 Pinion Seal
	H03-A107P-10 H03-A107E-10 H03-A108P-10	H03 PRO MAIN PCB H03 ECO MAIN PCB H03 PRO MAIN PCB ASM
	H03-A124-10	H03 DOOR SW PCB ASM
	H03-A125-10	H03 T-SENSOR ASM
	H03-A130-10	H03 W-SENSOR PCB
	H03-E111-10	H03 DC Motor
	H03-130-10	BLDC FAN (40)
	H03-A131-10	H03 Heater ASM

Image	Part No	Names of goods
	H03-E118-10	DRAIN SEAL
	H03-E116-10	H03 Styrofoam Ball
	H03-E127-10	H03 Hatcing Pad
	H03-E128-10	H03 Humidity Pad
	SR-A07-10	H03 Quail Egg Tray ASM
	SR-A01-10	H03 Goose Egg Tray ASM
	OSC-003-10	EZ SCOPE BODY
	OSC-002-10	EZ SCOPE HANDLE
	OSC-005-10	EZ BUTTON
	OSC-004-10	EZ COVER PLATE
	OSC-006-10	EZ SCOPE PCB
	OSC-001-10	EZ SCOPE HOOD
	OSC-010-10	EZ SCOPE LENS
	OSC-011-10	LED
	OSC-007-10	SHIELD SPONGE(L)
	OSC-008-10	SHIELD SPONGE(S)
	OSC-020-10	Y-CODE
	OSC-012-10	SCOPE LED

Rcom is designed for user's easy and convenient use.
It can be changed without notice for improvement in performance,
design, treatment, and software, etc.



www.RcomCo.com

North America Sales & Service

www.RcomCo.com

Manufacturer

AUTOELEX CO.,LTD.

- OFFICE : [F1] 3, Yanggeun-ro 287beon-gil, Yangpyeong-eup, Yangpyeong-gun, Gyeonggi-do, Korea
[F2] 1031-1, Seongmun-National Industrial Complex, Seongmun-myeon, Dangjin-si, Chungcheongnam-do, Korea
[F3] Deogam 612 Juchon Gimhae Gyeongnam 621-843 Korea

Rcom is the Best Design with High Quality, Value, and Performance!